



Colloque

Politiques de régulation des produits chimiques

Incidences et effets d'entraînement
du règlement européen REACH

Judi 23 juin 2011

Amphithéâtre Chapsal, Sciences Po - 75007 Paris



SESSION 1: REACH, PREMIERS ELEMENTS DE BILAN

Retour sur 3 ans d'expérience du suivi et de la mise en œuvre
du règlement par une agence d'expertise en appui des
autorités françaises

Henri BASTOS

Objectifs

- Rappel des différentes procédures
- Etat des lieux de leur mise en œuvre
- Perception par FR des difficultés et enjeux au niveau EU
- Système complexe – 3 ans seulement
- Analyse forcément partielle → alimenter la discussion de l'AM

Responsabilités des Etats membres

- Identifier substances intérêt (inquiétudes dangers / risques)
- Evaluation des substances
- Identification des mesures de gestion appropriées
 - Classification harmonisée
 - SVHC (autorisation)
 - Restriction
 - Autres mesure communautaire
- Elaboration des dossiers

Classification harmonisée

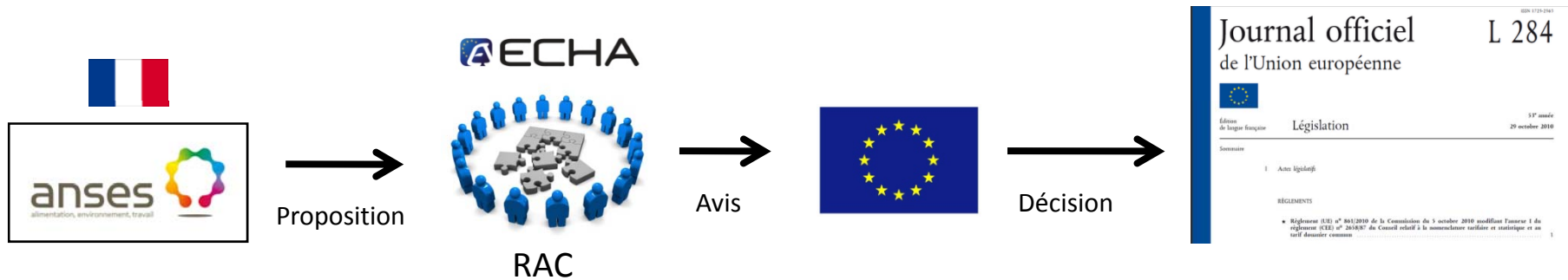

18 mois max.

BONCOLOR
1015, rue de la source 92350 PALSY - 146, 1 01 98 76 54 32

ACÉTONE



DANGER

Liquide et vapeurs très inflammables.
Provoque une sévère irritation des yeux.
Peut provoquer somnolence ou vertiges.
Tenir hors de portée des enfants.
Tenir à l'écart de la chaleur / des étincelles / des flammes nues / des surfaces chaudes. Ne pas fumer.
En cas de contact avec les yeux : rincer avec précaution à l'eau pendant plusieurs minutes. Enlever les lentilles de contact si la victime en porte et si elles peuvent être facilement enlevées. Continuer à rincer.
Stocker dans un endroit bien ventilé. Maintenir le récipient fermé de manière étanche.
L'exposition répétée peut provoquer dessèchement ou gerçures de la peau.

N° CE 200-662-2

Source: INRS

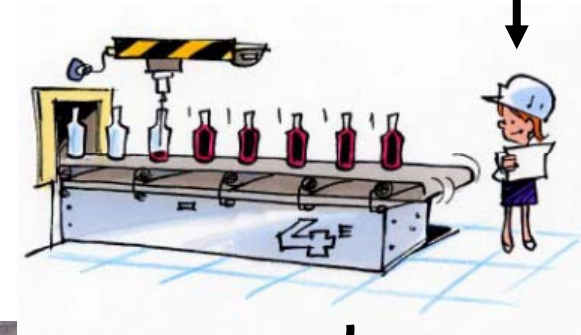

Classification harmonisée: états des lieux, enjeux

- 151 dossiers déposés
- 22 intentions
- 26 opinions adoptées
- Temps moyen = 8 mois environ



- 90 intentions prévues par an (ECHA)
- Arrivée des demandes d'autorisation !
- Ressources RAC – répartition des tâches – Appui EM
- Points faibles: nouvelles informations en cours de procédure

Evaluation

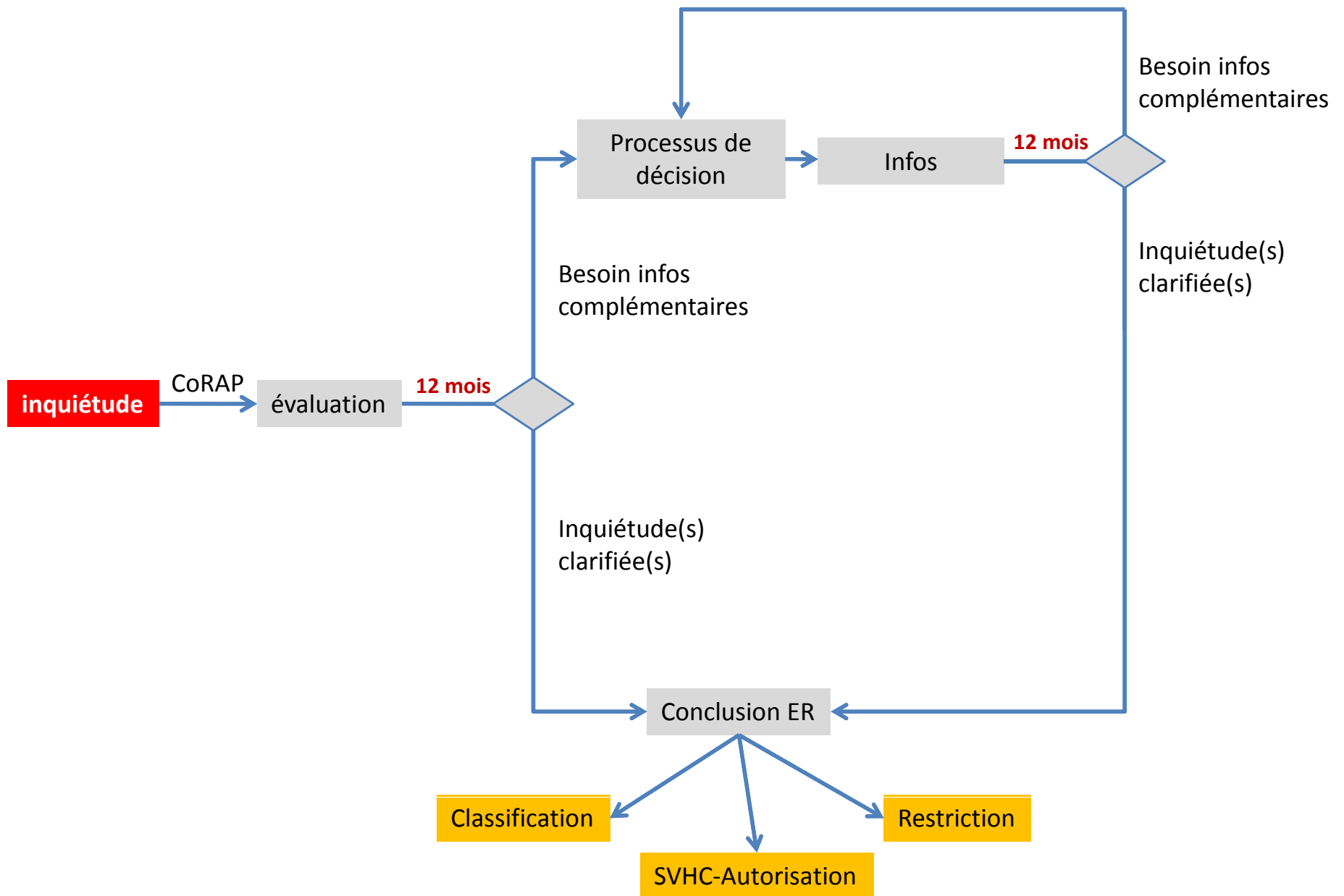

Evaluation: difficultés, enjeux

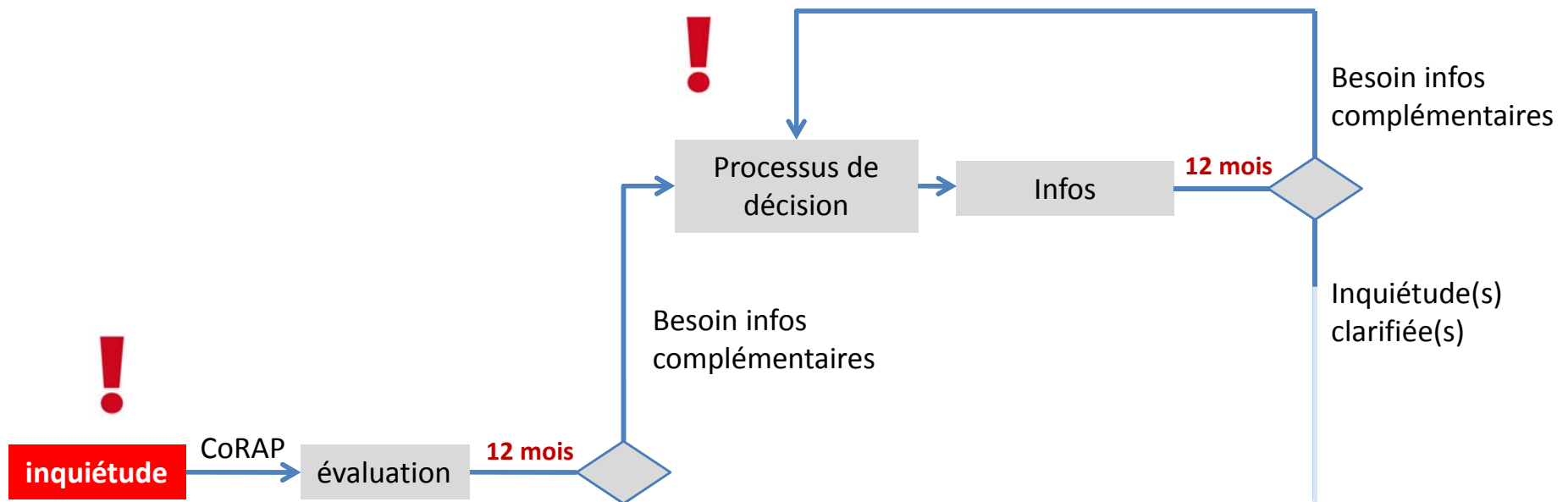

- Processus en construction !
- Publication CoRAP (début 2012)
- Intentions des EM: 40 (2012) -50 (2013) -50 (2014)
- Estimations de la COM: 950 (2012-2021): 3-4/EM/an
→ 95 / an environ



Exploitation automatique des données REACH-IT compliquée
Qualité des informations (?)
Bénéfice procédure / objectif (?)
Ne pas procéder à l'évaluation avant l'évaluation (!)

Restriction

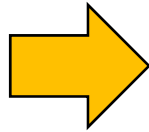

ECHA



RAC



SEAC



- Outil le plus approprié

- Impact socio-économique

Restriction: points forts, difficultés, enjeux

- 5 dossiers déposés (2 FR)
- Délais contraints (12 m + 18 m)
- Processus d'expertise pour l'évaluation des impacts socio-économiques
- Approche pluridisciplinaire

- Déficit d'informations - données (usages, expositions, substitution)

- Enjeux de développements méthodologiques: impacts sanitaires et environnementaux, ERS probabilistes
- Enjeux analyse comparative de l'efficacité mesures de gestion

- Développement réseau européen/international partage des informations et données disponibles (usages, expositions, substitution)



À la charge des Etats membres !

Autorisation

CMR 1A & 1B

« Equivalent concern »

PBT & vPvB

Liste candidate: SVHC



Numéro	Nom	Classement	Statut	Année
1
2
3
4
5
6
7
8
9
10
11
12
13
14
15
16
17
18
19
20
21
22
23
24
25
26
27
28
29
30
31
32
33
34
35
36
37
38
39
40
41
42
43
44
45
46
47
48
49
50
51
52
53
54
55
56
57
58
59
60
61
62
63
64
65
66
67
68
69
70
71
72
73
74
75
76
77
78
79
80
81
82
83
84
85
86
87
88
89
90
91
92
93
94
95
96
97
98
99
100

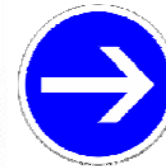

Notification articles

Informations consommateurs

Code	Nom	Classement	Statut	Année
1
2
3
4
5
6
7
8
9
10
11
12
13
14
15
16
17
18
19
20
21
22
23
24
25
26
27
28
29
30
31
32
33
34
35
36
37
38
39
40
41
42
43
44
45
46
47
48
49
50
51
52
53
54
55
56
57
58
59
60
61
62
63
64
65
66
67
68
69
70
71
72
73
74
75
76
77
78
79
80
81
82
83
84
85
86
87
88
89
90
91
92
93
94
95
96
97
98
99
100

Recommandation



Journal officiel de l'Union européenne L 284

Annexe XIV

Autorisation

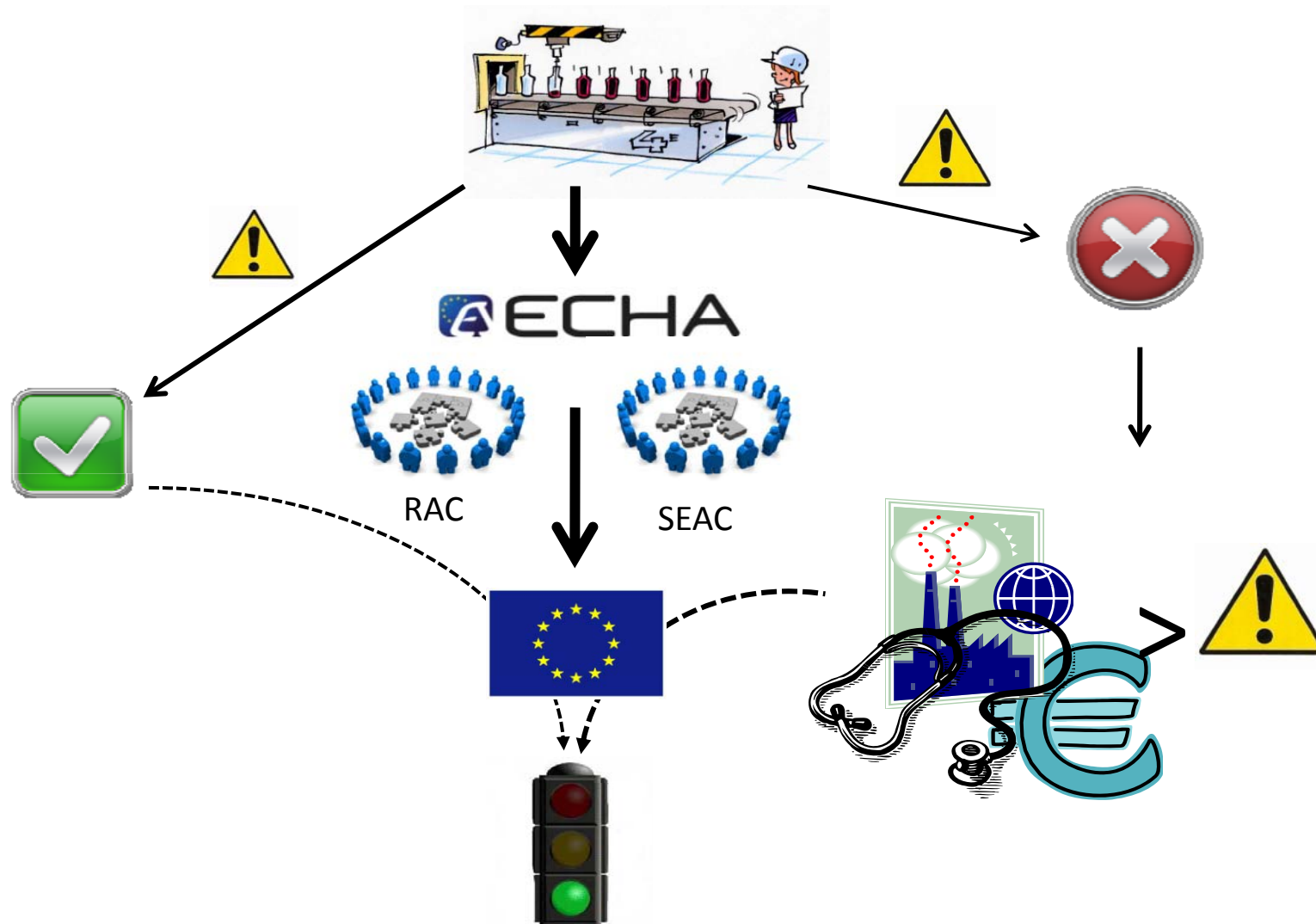

Autorisation: réflexions, enjeux

- Nouvel outil de gestion phare
- Attentes importantes
 - Potentiel important de substances SVHC
 - Annexe VI CLP = centaines CMR / Liste candidate = 53 SVHC)
 - Indicateur efficacité de REACH (?)
- Workshop ECHA 2009
 - Pertinence et bénéfique outil (efficacité / objectifs santé humaine – environnement
 - Identification SVHC: autorisation pas forcément visée
 - Best-RMO (informel) – « stratégie de réduction des risques »

Conclusions

- Mise en place progressive procédures
- Déjà un bénéfice important de la nouvelle réglementation
 - Délais contraints
 - Informations minimales sur les propriétés des substances



usages / expositions

- Renversement de la charge de la preuve \neq EM au repos!
- Défis méthodologiques et organisationnels importants (niveau EU et international)
- Efficacité REACH ne se mesure pas forcément au nombre de dossiers réalisés !